

1001

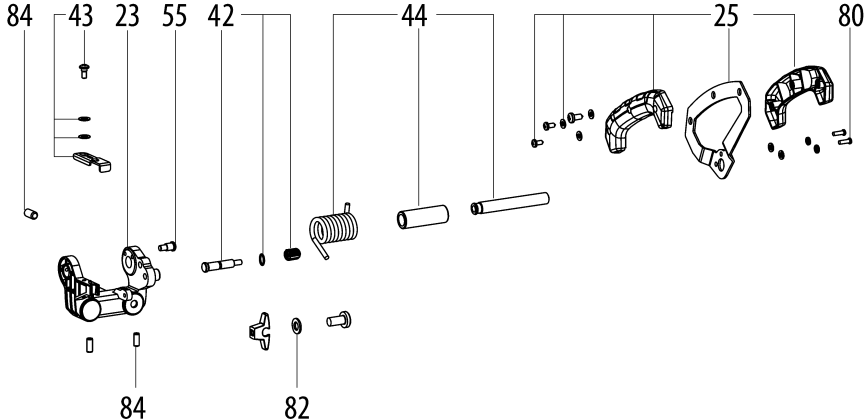

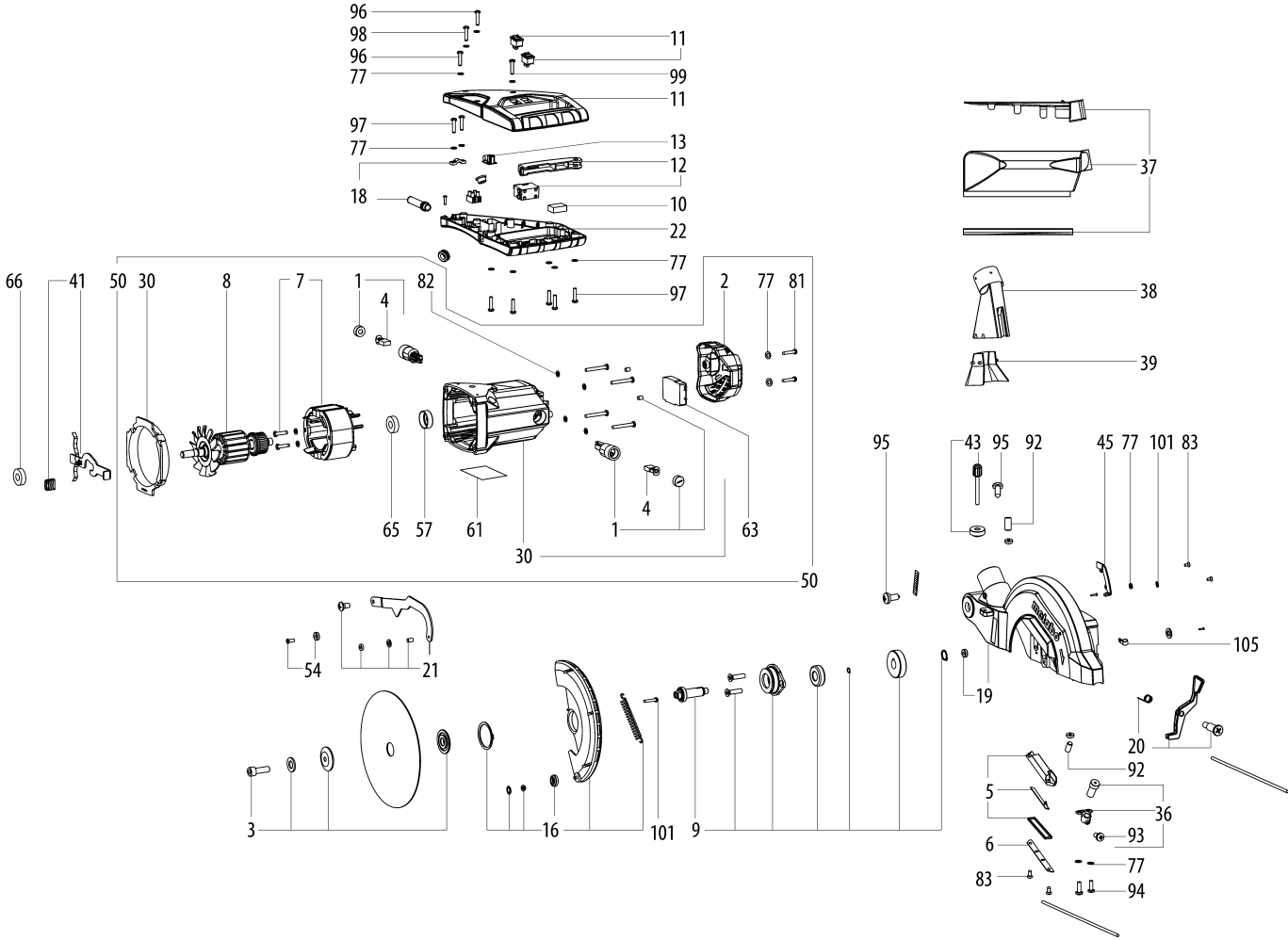



Position	Antal	Type nr.	Beskrivelse	PG
1	1	316080250	KULHOLDER KOMPLET	16
2	1	343435820	Motor cover	15
3	1	316060640	Flange compl.	22
4	1	316092330	Carbon brush set	17
5	1	343436090	LED-Lamp	20
6	1	343436110	Cover lighting	11
7	1	310011450	Stator	39
8	1	310011500	ARMATURE	41
9	1	316060710	Gear-box compl.	29
10	1	343254900	Condenser	11
11	1	316060720	OVERGREB cpl.	15
12	1	316092430	Switch compl.	21
13	1	343440900	Power supply	24
14	1	316055970	DREJEPLADE KOMPLET KS 216	40
15	1	316055940	Table compl.	44
16	1	316056330	Safety guard compl.	26
17	1	315419090	Foot compl.	13
18	1	316060860	stress relieve compl.	23
19	1	316056250	Wheel guard compl.	39
20	1	316056730	Release lever compl.	14
21	1	316056930	HOLDER KLINGEAFDÆKNING	25
22	1	343435740	Handle bottom part	25
23	1	316056090	Motor bracket compl.	30
24	1	316056120	Pivot compl.	46
25	1	316060950	Handle compl.	23
26	1	316092340	Detent compl.	22
27	1	316056800	Control grip compl.	19
28	1	315418530	Table side extension right	27
29	1	315418500	Table side extension left	27
30	1	316056290	Motor housing compl.	29
31	1	316075690	Workpiece holder compl.	22
32	1	316075440	Bevel clamping comp.	28
33	1	316056010	Stop compl.	33
34	1	315418550	Rear pivot compl.	36
35	1	343436030	Table insert	15
36	1	343436070	LASER MED HOLDER	22
37	1	316075450	UDSUGNINGSSÆT KOMPLET	13
38	1	343435800	Cover dust collector	16
39	1	343436280	Extraction funnel	11
40	2	343436170	CABLE BRACKET	11
41	1	316056890	Spindle lock compl.	15
42	1	316061380	TANSPORTLÅS KOMPLET	12
43	1	316057470	Depth stop compl.	12
44	1	316061420	tipping axis compl.	26
45	1	343441110	Cover (cable channel)	11
46	2	344113030	Plug in buffer	11
47	1	339136700	cover pivot	11
48	1	316056830	Set screw compl.	11
49	1	316061450	Scale set compl.	15
50	1	316061500	Motor compl.	53
51	1	339147660	GLIDEBLIK 455	13
52	1	316061530	End stop cpl.	15

Position	Antal	Type nr.	Beskrivelse	PG
53	1	343436220	Star grip screw	11
54	1	316061540	Bearing compl.	14
55	1	341722210	Stop screw	11
57	1	344113050	Rubber bushing	11
58	1	316061550	VÆRKTØJSHOLDER cpl.	11
61	1	338063100	Rating plate	11
62	1	343437020	Star grip screw	11
63	1	343084080	Electronic unit	29
64	1	343437050	Star grip screw	11
65	1	143111440	KUGLELEJE 6001 2RS	27
66	1	143113370	LEJE DSE 130	24
67	1	141132030	Hex nut	11
68	1	141150050	SKIVE	11
69	1	141150390	SKIVE 5348	11
70	1	141113890	ZH-SKRUE M 6X25	12
71	1	141150130	SKIVE	11
72	1	141155240	SKIVE	12
73	1	141130890	Hexagonal lock nut	12
74	1	141156200	Washer	11
75	1	141113840	SKRUE	12
76	1	141110590	LH-SKRUE M 5X10	11
77	1	141150010	SKIVE F / KS 1468	11
79	1	141112180	U/SÆNK,SKRUE M 4X12	11
80	1	141116780	LH-SKRUE M 5X16	11
81	1	141123710	Fillister head screw	11
82	1	141150020	SKIVE	11
83	1	141123840	Countersunk screw	11
84	1	141124510	SKRUE FLAT PT M 6X8 VER	11
87	1	141150360	Lock washer	11
88	1	141110540	LH-SKRUE M 4X10	11
90	1	141124460	AKSEL TIL SKRUEHÅNDTAG	11
91	1	141131010	SEKSKANT-MØTRIK M 8	11
92	1	141123410	Grub screw	11
93	1	141116480	GEVINDSTIFT M 4X8	11
94	1	141113590	ZH-SKRUE M 4X12	12
95	1	141124470	SKRUE	11
96	1	141111430	SKRUE	12
97	1	141118730	SELVSK,SKRUE ST 4.2X13	11
98	1	141116800	SELVSK,SKRUE ST 4.2X16	11
99	1	141123940	Self-tap. fill. h. screw	11
100	1	141113220	LH-SKRUE M 4X8	11
101	1	141150350	SKIVE	11
105	1	343441120	CABLE CLAMP	11
1001	1	338505980	Wiring diagram	

